



Explosion Proof Light I Series



Industrial Field & Hazardous Locations

VENAS

Applications

Oil and Gas industry

- All petroleum production and refining
- Petroleum loading and transportation
- Petroleum storage and retail
- LNG industry

- All mining operations and service

Chemical industry

- All types of paint facilities
- Chemical production and storage

Ocean, marine and aerospace field

- Ocean platform operation facilities and structure
- Aerospace clean room and production
- Ocean vessel operations

Metal treatment

- Steel and aluminum factories
- Pumping stations in any environment
- Metal smelting, foundry and fabrication

Food and alcohol industry

- Flour and fine particle production and storage
- Food and distilling production
- Alcohol industry

Other high humidity, high dust, high temperature, vapor locations



Explosion Protection

Marking Atex

II2 G Ex db op is IIB T4/T5 Gb

II2 D Ex op is tb IIIC T135°C Db IP66

Marking IECEX

Ex db op is IIB T4/T5 Gb

Ex op is tb IIIC T135°C Db IP66

Marking UL844^(North American)

Class I, Division 1, Groups C, D

Class I, Division 2, Groups A, B, C, D

Class II, Division 1, Groups E, F, G

Class II, Division 2, Groups F, G

Class III

Marking Marine

UL1598, UL1598A

ABS

Other Rating

IP 66

Features

- Working Temperature: -40°C ~ +60°C.
- High quality SMT LED and Meanwell Driver.
- Light-weight design by aircraft aluminum.
- Heavy-duty and high impact resistance.
- Three connection cable entry points.
- Replaceable LED board and drivers.
- Integrated junction box for driver with emergency back up.
- Dimmable and battery back up function available.
- Marine rating powder coated appearance treatment.
- Up to 5 years limited warranty option.
- Emergency Battery back up to three hours.
- Various installation ways for different applications.
- Glass lens or Glass with polycarbonate lens to make bigger beam angle.



14

Materials

- Housing: Die-casting Aluminum
- Lens: PC
- Hardware: stainless steel
- Mounting Bracket: stainless steel



Specification

Model	Wattage	CCT	Voltage Options	Lumens	Warranty	CRI	Emergency Time(Optional)
EX-20W I2YZDA	20	2200K-7000K	AC100-277V AC200-480V DC12-36V	2800	5 years	>70	3 hours
EX-40W I2YZDA	40			5600			
EX-60W I2YZDA	60			8400			
EX-60W I4YZDA	60			8400			
EX-80W I4YZDA	80			11200			
EX-100W I4YZDA	100			14000			
EX-120W I4YZDA	120			16800			

"I2, I4"=Product code "Y"=D or N: Dimmable or Non-dimmable "Z"=CCT, from 2200~7000K.
 "D"=Beam angle, D40 for 40°, D60 for 60°, D90 for 90°, D120 for 120°. A for cover info., blank for flat cover, C spherical cover.

Packing Information

Model	Quantity/ Ctn	Length(cm)	Width (cm)	Height(cm)	Net weight(kg)	Gross weight (kg)
I2	1	77	34	26.5	12	14
I4	1	136	34	26.5	18.5	21.5

Light Distribution

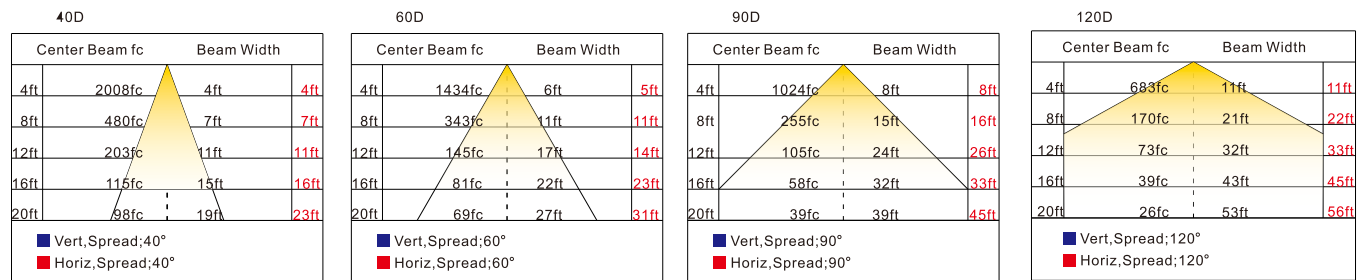

Dimension Unit: mm or inch

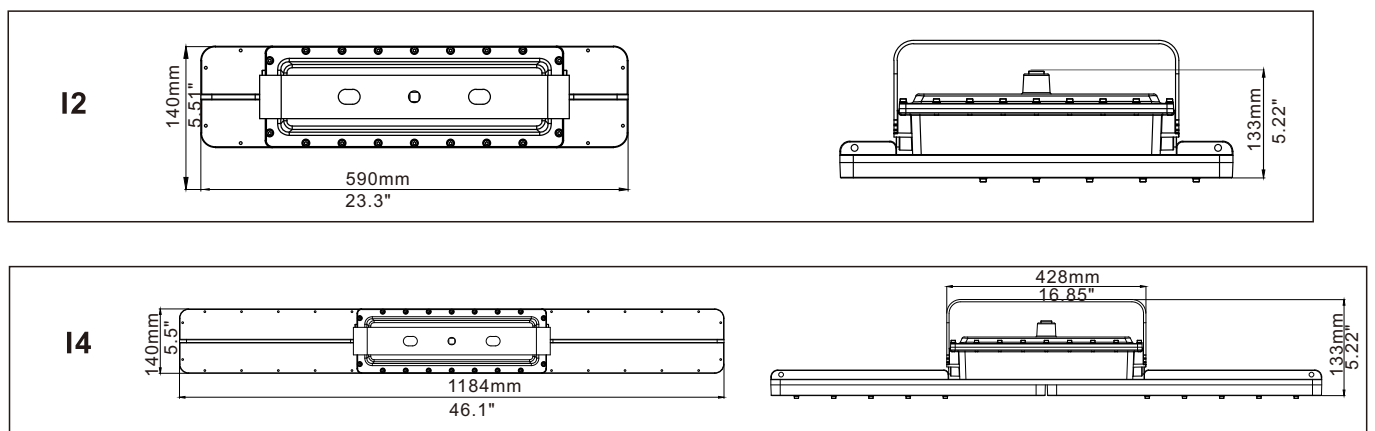

Mounting

No.1 Ceiling Mounting

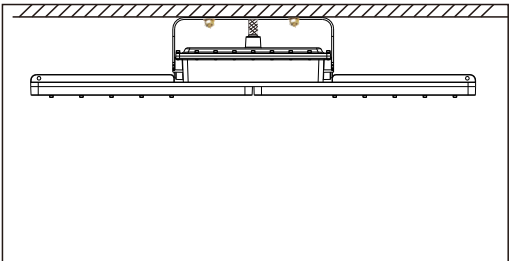

No.2 Pole Bracket Mounting

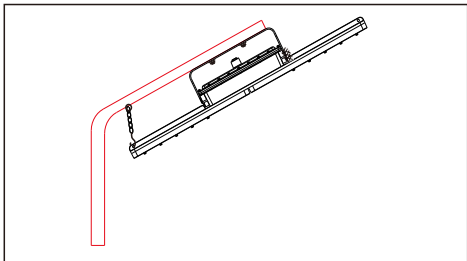

No.3 Wall Mounting

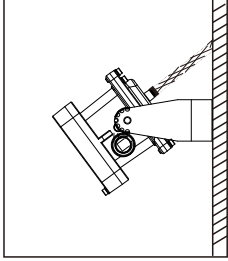

No.4 Chain Mounting

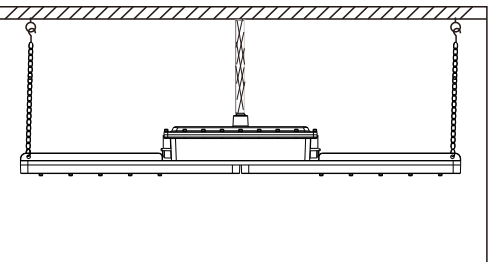

No.5 Pole Pendant Mounting

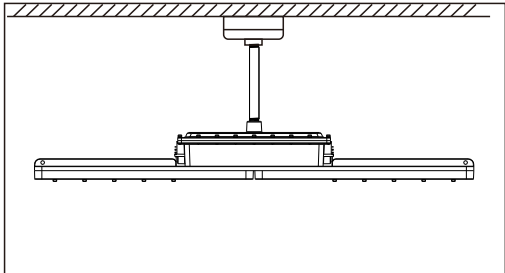

Accessories

Junction Box



Bracket



Straight Pipe



Chain



Metal Conduit



Bended Pipe



12

